

HL616HLW/5 2,1 l/s DN160

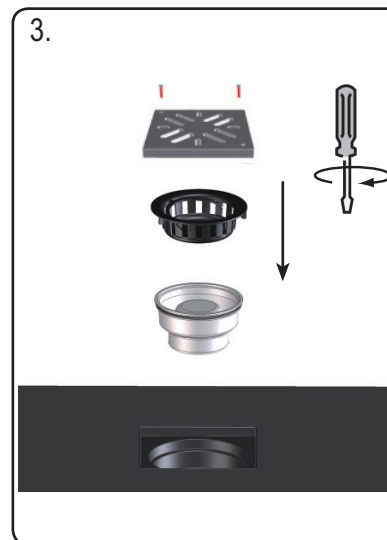
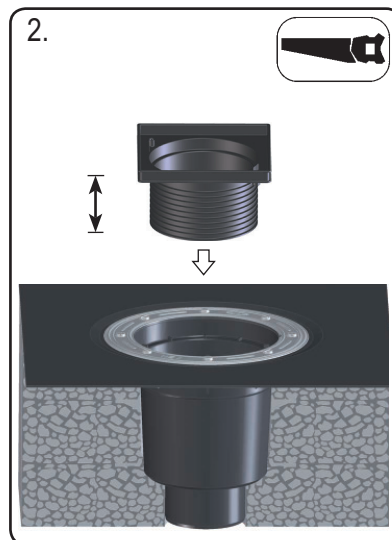
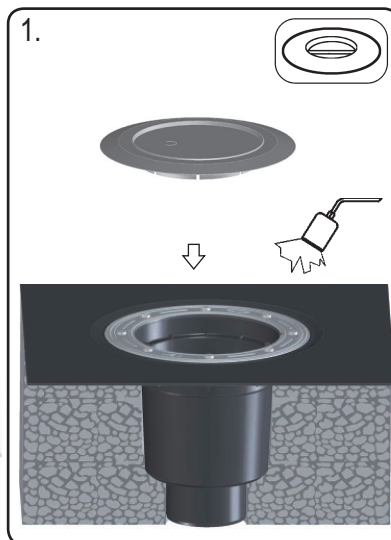
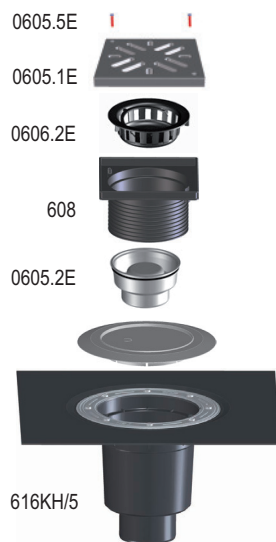
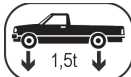
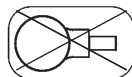
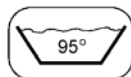
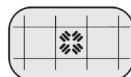

D Großablauf
I GRANDO SCARICO
GB MAJOR DRAIN

TR BÜYÜK ÇAPLI SÜZGEÇ
CZ/SK VELKOKAPACITNÍ ODTOK
HR VELIK SLIVNIK

H NAGYLEFOLYÓ
PL WPUST PODWÓRZOWY
SLO VELIKI ODTOK

RO RECEPTOARE MARI
PYC Дворовый трап
BUL Голям сифон

2011/03