

HL69B/2

8,17 l/s
DN125

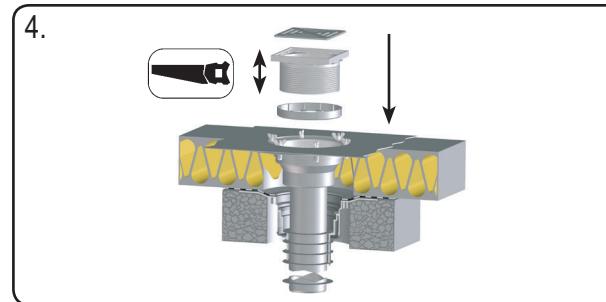
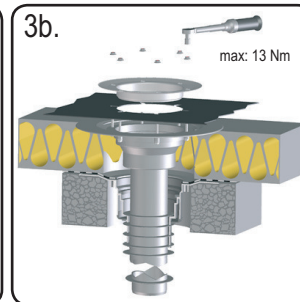
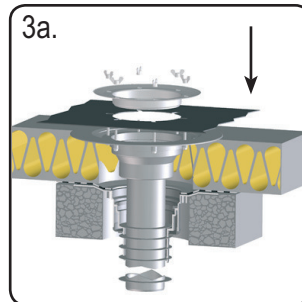
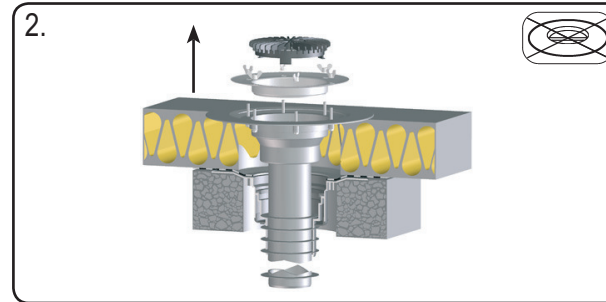
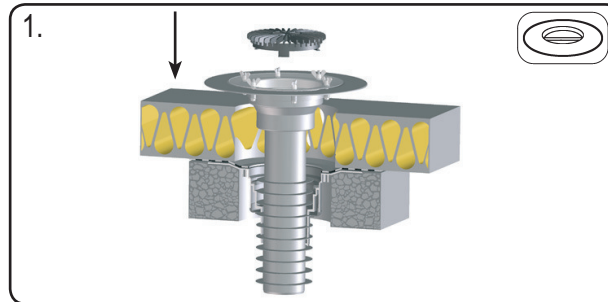
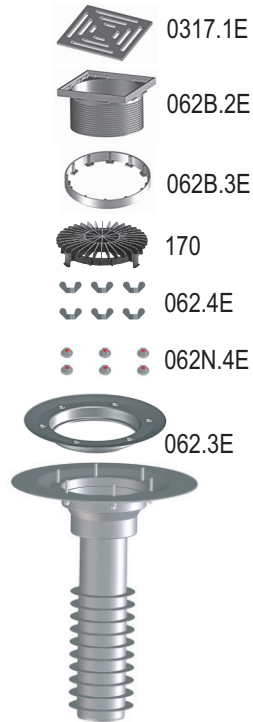
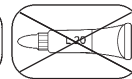
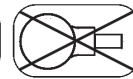

D Flachdach-Ablauf
I Scarico per tetti piani
GB Flat-roof drain

TR Düz çatı süzgeci
CZ/SK Střešní vtok
EX-YU slivnik za ravni krov

H Lapostető lefolyó
PL Wpust dachu płaskiego
SLO Odtok ravne strehe

RO Scurgere de pe terase
РУС Воронка для плоской кровли
BUL воронка за плосък покрив

08.06.2010